



# FITTING INSTRUCTIONS

making everyday smoother



- Increased comfort • Better driveability • More safety



## MERCEDES BENZ VITO

with VB-FullAir 2-Corner rear axle air suspension

for kit 105 02 19 22x

## What's changed

|                     |  |  |  |
|---------------------|--|--|--|
| New version number: | V1.2   |  |  |
| Release date:       | 12/19/2012   |  |  |
| Changed compared to | V1.1   |  |  |
| Page: (New version) | Changes  |  |  |
| 11                  | Description for mounting ball joints in suspension arm changed |  |  |
| 12                  | Heightsensor rods for 4X4 model added                          |  |  |
| 17                  | Description for getting speed signal changed                   |  |  |
| 28/29               | What to do when xenon lights are fitted                        |  |  |



*air suspension*



© 2012, VB-Airsuspension B.V.

All rights reserved. No part of this publication may be reproduced, stored in a retrieval system, or transmitted in any form or by any means, electronic, mechanical, photocopying, recording or otherwise, without the publisher's prior consent. That does also count for the schemes and drawings.

## Contents

|  |           |
|--|-----------|
| <b>1. Safety regulations</b>                 | <b>4</b>  |
| <b>2. General fitting regulations</b>        | <b>5</b>  |
| <b>3. Overview of the air-suspension kit</b> | <b>6</b>  |
| <b>4. Mounting the air-suspension kit</b>    | <b>7</b>  |
| 4.1 Preparations                             | 7         |
| 4.2 Mounting the air suspension parts        | 7         |
| 4.3 Compressorbox                            | 10        |
| 4.4 Heightsensors                            | 11        |
| 4.5 Wiring harness                           | 12        |
| 4.6 Remote                                   | 15        |
| 4.7 Remaining connections                    | 16        |
| 4.7.1 Speedsignal                            | 17        |
| 4.7.2 Contact plus                           | 17        |
| 4.8 Warranty                                 | 19        |
| 4.9 Calibration                              | 20        |
| <b>5. Checklist</b>                          | <b>21</b> |
| 5.1 System finishing                         | 21        |
| 5.2 Functions of system                      | 21        |
| <b>6. Wiring diagram</b>                     | <b>22</b> |
| <b>7. Exploded view</b>                      | <b>24</b> |
| 7.1 Compressorbox                            | 24        |
| 7.2 Air-spring                               | 26        |
| 7.3 Heightsensor                             | 26        |
| <b>8. Xenon modification</b>                 | <b>28</b> |
| <b>9. Notes</b>                              | <b>30</b> |

# 1. Safety regulations

## Personal safety regulations

- Always wear appropriate safety clothes and safety shoes.
- Do not wear any rings, watches, or free hanging clothes.
- Never keep any loose goods in pockets of clothes.
- Bind long hair together.
- Never use defect tools. Use tools only for the purpose where it is meant for.
- Wear safety goggles.

## General safety regulations

- Always use a car lift to perform the operations.
- Be sure the vehicle is always supported properly when necessary.
- Be sure the vehicle can not roll away.
- Incapable fitting operations may result in dangerous situations.

## Used Symbols

### Attention



***When the warning symbol is displayed, information of great importance to the safety and / or health of the involved persons is provided. This symbol is also used in operations that are crucial for the correct mounting of the air suspension set.***

### Tip



***When the tip symbol is displayed, advice is given to make the mounting of the air suspension set more easy.***

### Torque



***Every bolted joint in this manual comes with a torque.***

***xx Nm***

## 2. General fitting regulations

This manual has been carefully crafted to provide the best way to fit the air suspension mentioned on the cover of this manual. However, the manual is a random indication of the technical specifications at any given time.

VB-Airsuspension reserves the right to make technical changes in the air suspension kit without any notification.

Fitting of the air suspension kit can only be done in a from VB-Airsuspension authorised workshop. The fitting can only be done by authorised mechanics. The mechanics must have proper experience in electric/electronics, pneumatics and regular vehicle technics.

- When necessary, use the work-shop manuals of the vehicle.  
Always follow the directions of the vehicle manufacturer, unless otherwise expressly stated in this manual.
- Work clean.
- Always tighten the bolts and nuts according the recommended torque.
- Whenever changes are made to the original corrosion protection, restore it immediately. For this purpose use for example protective coating or spray wax.
- Always re-fit the removed wires and tubes on the original way.
- Always secure the wires and air tubes with plenty of tie-wraps. Secure all connectors properly and make sure that there is no stress on them.
- All electrical cables must be kept at least 100 mm away from the ABS/ESP block, its sensors and other controllers.
- Make sure the air-tubes do not make sharp corners and can not bend or wear against other parts.
- Connecting electrical cables or air-tubes to brake lines is strictly prohibited!
- Make sure no tools, cleaning rags or other materials remain under the car.
- Check the air suspension after finishing the fitting according the checklist.
- Check after the fitting, the system for air leakage.
- When finishing the fitting, always make a test drive.
- Make sure that the right calibration support are available, for this kit the right calibration support are:

| Axle      | Calibration height: | Partnumbers:  |
|-----------|---------------------|---------------|
| Rear axle | <b>X = 430mm*</b>   | 009 000 00 54 |

\* The X-value is the distance between the middle of the wheel and the wheel arch.

- The air-suspension is split up in two corners, which correspond to one corner of the vehicle. When a part is specific for one corner, this will be marked with a coloured sticker.

| Colour       | Description       |
|--------------|-------------------|
| <b>Black</b> | <b>Right rear</b> |
| <b>Green</b> | <b>Left rear</b>  |

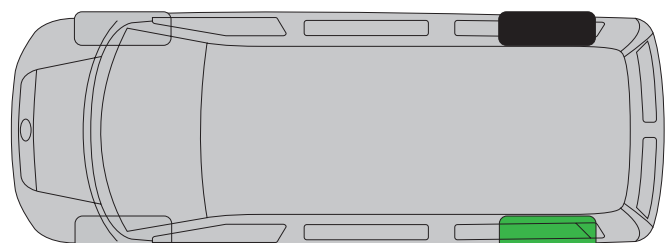

### 3. Overview of the air-suspension kit



The air-suspension kit consists of numerous different parts. To keep things clear, only the main parts have been included on the above picture. The more common parts, like for example the fitting materials, have been left out.

| Number | Description                    |
|--------|--------------------------------|
| 1      | Air springs                    |
| 2      | Upper spring plates            |
| 3      | Remote                         |
| 4      | Heightsensor + bracket right   |
| 5      | Heightsensor + bracket left    |
| 6      | Clamping plate                 |
| 7      | Heightsensor rod L= 50mm HtoH  |
| 8      | Compressorbox + wiring harness |

For an overview of the place where the different parts are located, please see the chapter “Exploded View” in chapter 7. You can also find the partnumbers there.



## 4. Mounting the air-suspension kit

### 4.1 Preparations

1. Support the vehicle properly.
2. Remove the lower bolt of the shockabsorbers.



***The bolt can be used again.***

3. Raise the vehicle until the springs can be removed.
4. Remove the springs with the upper mounting rubbers.

5. Remove the lower mounting rubbers.



### 4.2 Mounting the air suspension parts

1. Mount the upper spring plates to the chassis.



**4x Countersunk allen screw M8x16**

**20 Nm**



2. Mount the air springs to the upper spring plates.

|   |                             |
|---|-----------------------------|
|  | <b>4x Flare lock nut M6</b> |
| <b>8 Nm</b>   |                             |

 **The air spring should be mounted with the air-coupling to the front of the vehicle, so that the VB-Airsuspension logo to the back points.**

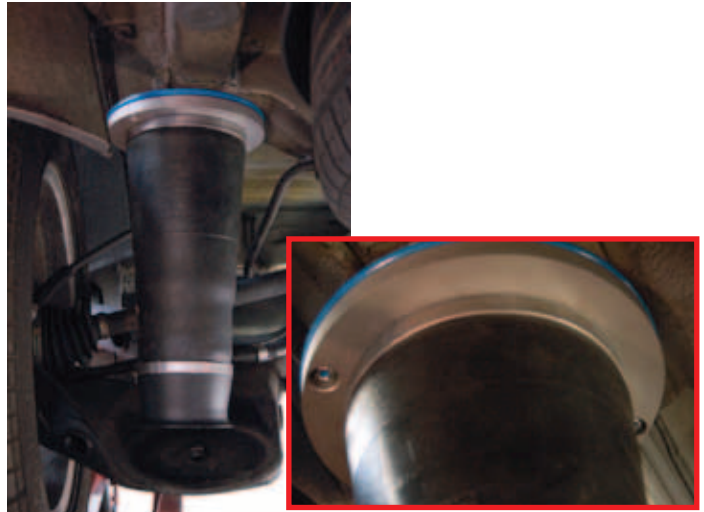

3. Mount the air spring to the suspension arm.

|   |  |
|---|--|
|  | <b>2x Bolt M8x30*</b><br><b>2x Washer M8</b> |
| <b>6 Nm</b>   |  |

 **Note the placing of the clamping plates, they can be mounted just in one way.**

 **Don't secure the bolts.**



4. Protect the air-tubes with a black corrugated hose.

 **The black corrugated hose with a length of 0,3m should be mounted on the green air-tube**

 **The black corrugated hose with a length of 1m should be mounted on the black air-tube**

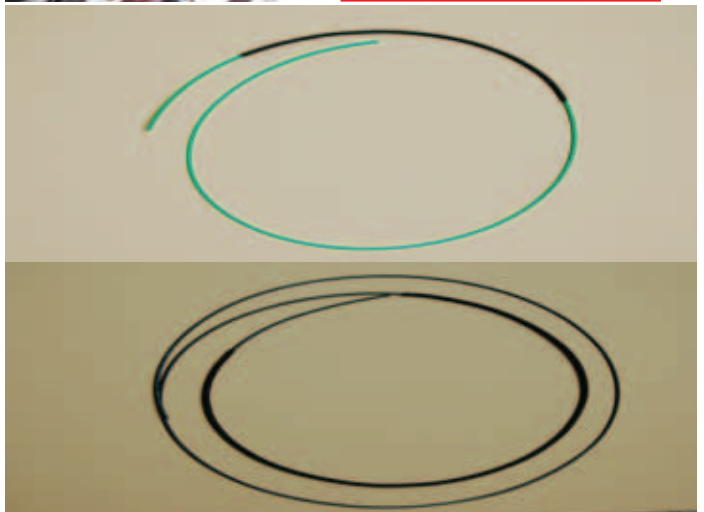



5. Connect the **black** air tube to the right air spring and slide the black corrugated hose over the air-tube to the air-spring.
6. Place the black air-tube to the left of the vehicle, over the differential along the chassis beam. (marked with the red line)
7. Connect the **green** air tube to the left air spring and slide the black corrugated hose over the air-tube to the air-spring.

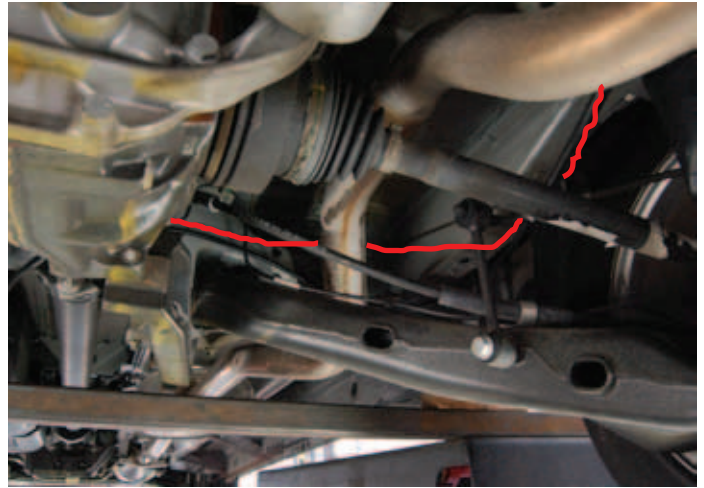

***Make sure that the air tubes are clean and undamaged. Cut the air tube right with an air pipe cutter, of the special tools.***

8. Mount the lower side of the shock absorber but don't secure them jet. Use sealant to secure the bolts.



***2x Original bolt\****

***180 Nm***



***Don't secure the bolts.***

\* The bolt have to be tighten at ride height

9. Pump with an external air-supply some air in the air-springs, so the rubber can set itself and the car is on ride height.



### 4.3 Compressorbox

1. Slide the compressorbox on the left side of the vehicle between the drive shaft and the suspensionarm.

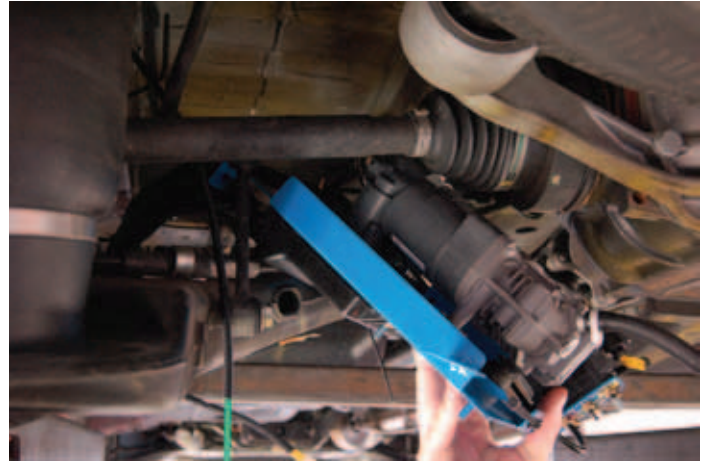

2. Mount the compressorbox to the chassis.

|   |   |
|---|---|
|  | <b>3x Bolt M8x20</b><br><b>3x Washer M8</b> |
| <b>20 Nm</b>  |   |

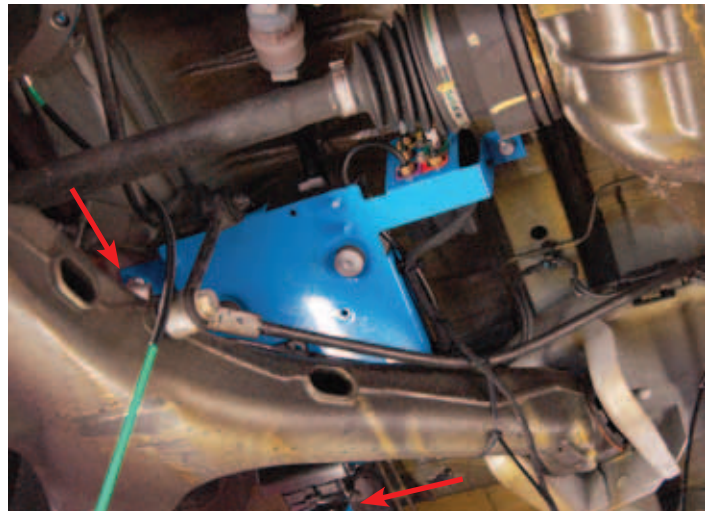

3. Slide the suction-tube into the chassis.

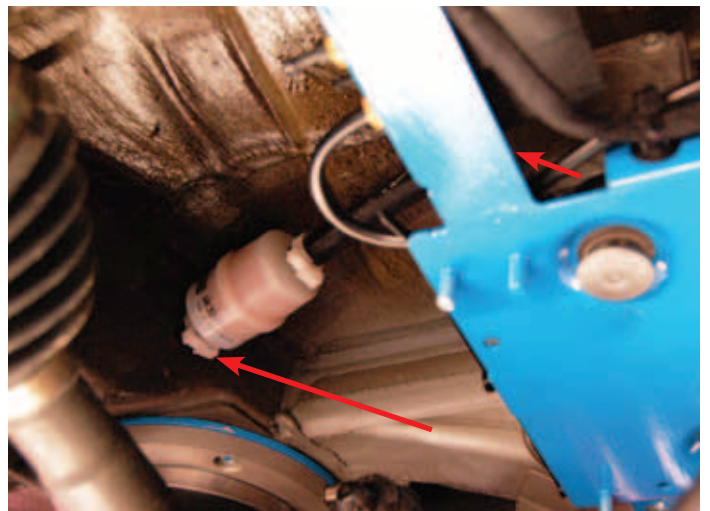



## 4.4 Heightsensors



**If the vehicle has Xenon lights, please first continue with chapter 8.**

1. Mount three blind rivet nuts M6 into the three holes in the chassis. Do this for both sides of the vehicle.



**6x Blind rivet nuts M6**

-

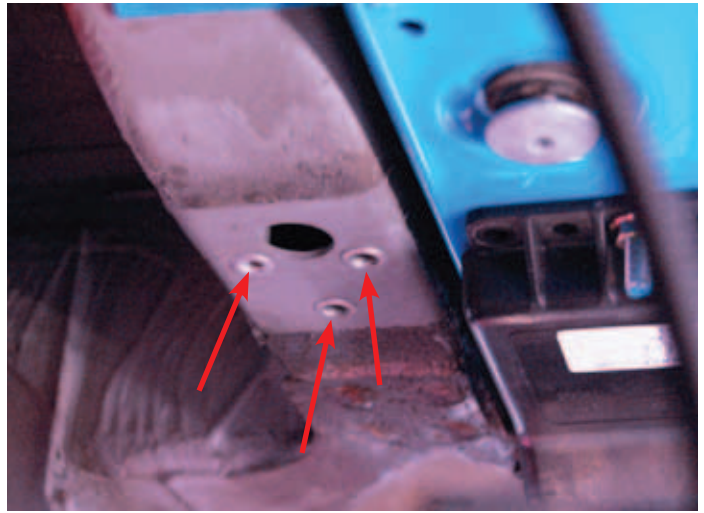

2. Mount the left heightsensor to the chassis.



**3x Bolt M6x16**  
**3x Washer M6**

**8 Nm**

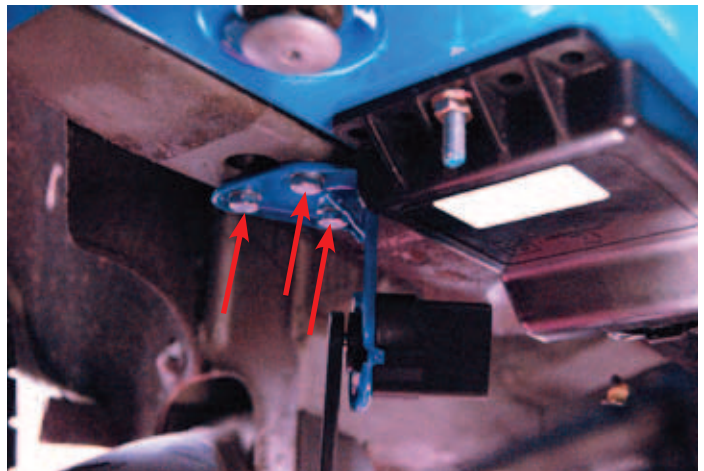

3. Mount the right heightsensor to the chassis.



**3x Bolt M6x16**  
**3x Washer M6**

**8 Nm**



4. Drill a hole of Ø5mm in the suspension arm.
5. Cut a M6x1 thread into this hole.



6. Mount the balljoint to the suspension arms.



**2x Ball joint M6**  
**2x Washer M6**

**8 Nm**



7. Check the length of the heightsensor rods.  
- **50 mm** measured from heart to heart.

When the vehicle is a 4X4 model, the height-sensor rods should be **-105 mm** , measured from heart to heart

8. Mount the heightsensor rod to the right heightsensor and the ball joint.



**The arm of the right heightsensor should be pointing to the rear of the vehicle.**



9. Mount the heightsensor rod to the left heightsensor and the ball joint.



**The arm of the left heightsensor should be pointing to the front of the vehicle.**



#### 4.5 Wiring harness

1. Lay the **black** heightsensorcable along the black air-tube to the right rear heightsensor.
2. Mount the air-tube and the cable with 3 or 4 cable ties with feet Ø6,5 to the chassis. (see arrows)



**NEVER connect cables or tubes on the brake lines.**



**Make sure that the air tubes aren't near hot or moving parts.**

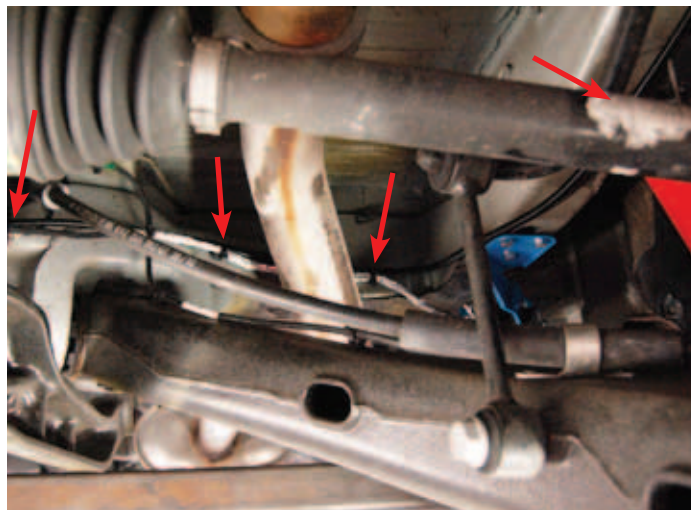

3. Lay the **green** heightsensorcable to the left heightsensor.
4. Mount the heightsensorcable with cable ties with feet Ø6,5 to the chassis (see arrows).
5. Connect the heightsensorcables to the heightsensors.



**Push the connector until you hear a "click".**



**There never may be tension on the wiring and the plug connections.**





6. Lay the air-tube of the right air-spring to the compressorbox.
7. Lay the air-tube of the left air-spring to the compressorbox.
8. Mount the **green** air-tube to the connection with the **green** mark on the compressorbox.
9. Mount the **black** air-tube to **black** connection on the compressorbox.

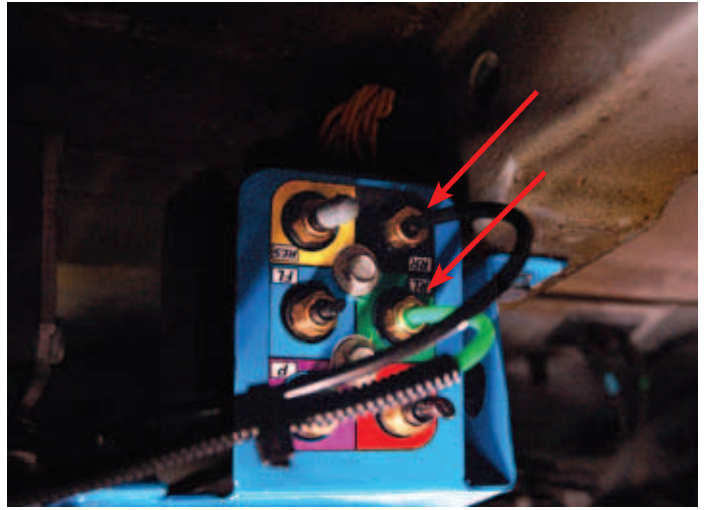

10. Lay the wiring harness along the leftside of the vehicle chassis along the fueltank to the front of the vehicle.(see red lines)
11. Mount the wiring harness with cable ties to the chassis.

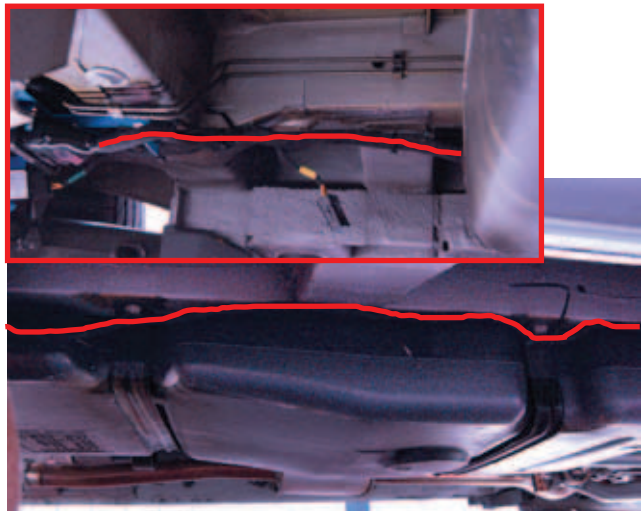

***Make sure that you have used enough cable ties to fasten the cable.***

12. Remove the seat cover.



13. Remove the nut of the Earth point.  
(see arrow)
14. Remove the support where the battery is mounted with.
15. Remove the battery.

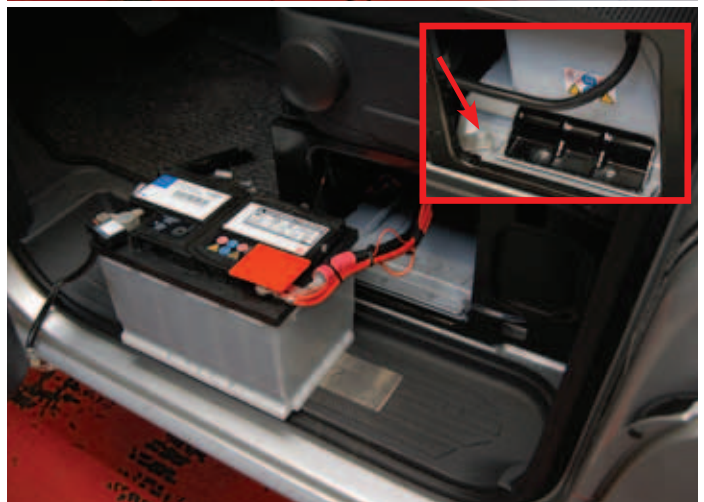



16. Place the wiring harness, through the rubber bushing into the floor of the seatframe.
17. Mount the wiring harness with cable ties to the chassis.

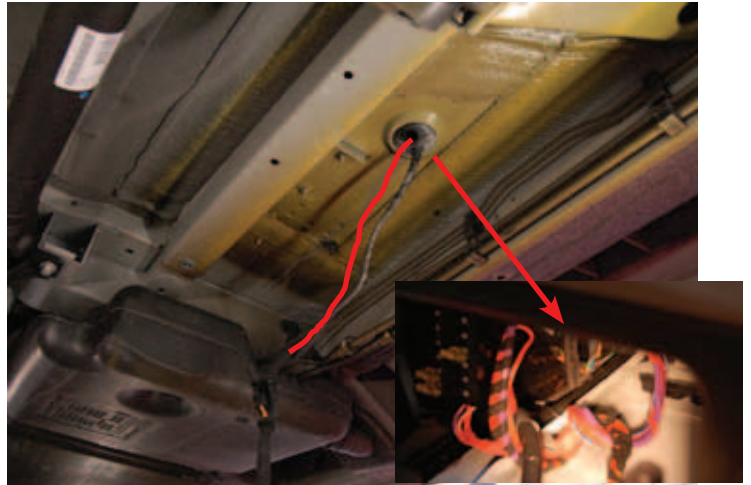

18. Mount the red cable on the positive(+) terminal of the battery.
19. Mount the red cable with cable ties to the battery cable.(see picture)



20. Connect the red wires in a fuse block (F1).
21. Connect the yellow wires in the other fuse block(F2).
22. Mount the battery back under the seat.

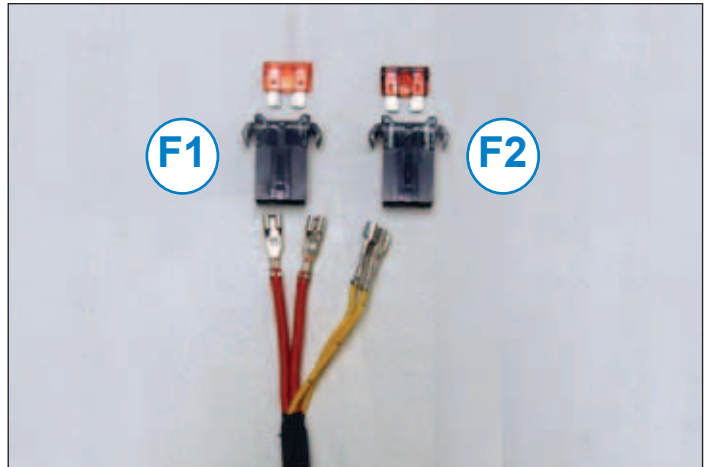

23. Mount the earth cable with an eyelet of 8mm of the VB wiring harness to the earth point of the car.



24. Mount the fuse blocks with cable ties to the earth cable of the battery.

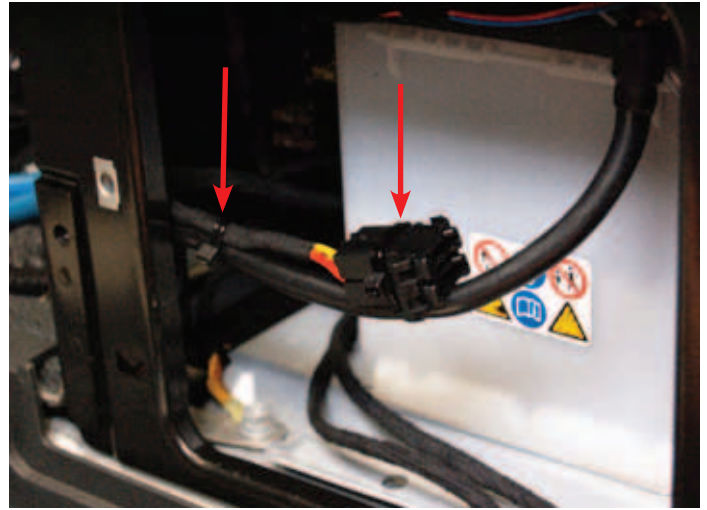

#### 4.6 Remote



***Make sure the remote control never gets in the way of the airbags.***

1. Lay the cable of the remote in the corner between the covers to the opening of the battery. (Red line)
2. Mount the cable with cable ties with feet  $\varnothing 6,5$  to the seat frame. (see arrows)
3. Connect the cable of the remote to the wiring harness from VB.
4. Secure the cable out of sight in the seat frame.



3. Connect the cable of the remote to the wiring harness from VB.
4. Secure the cable out of sight in the seat frame.

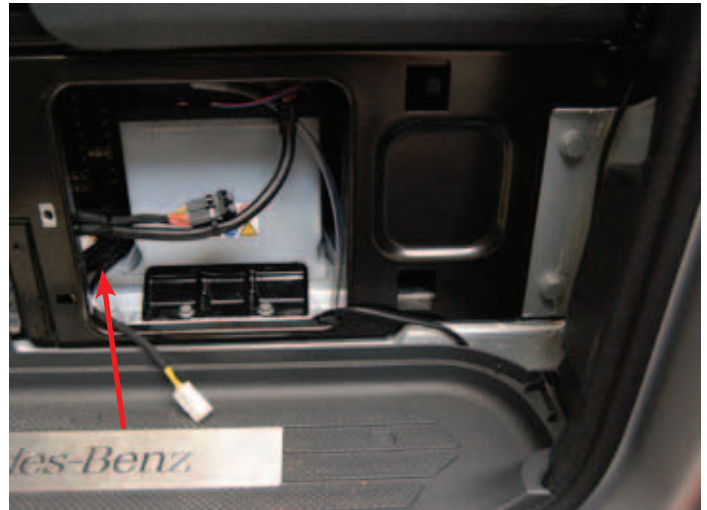

5. Search for a good position to hang the remote control.
6. Mount the holder.
7. Hang the remote control in the holder.



***VB-Airsuspension recommended the place on the picture. Make sure that the remote control never comes in the way of the airbag.***

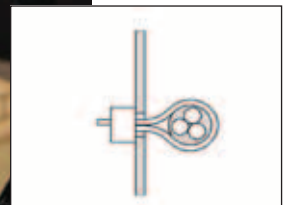



#### 4.7 Remaining connections

1. Remove the cover of the A-style on the drivers side.



2. Remove the entry trim of the cabin.

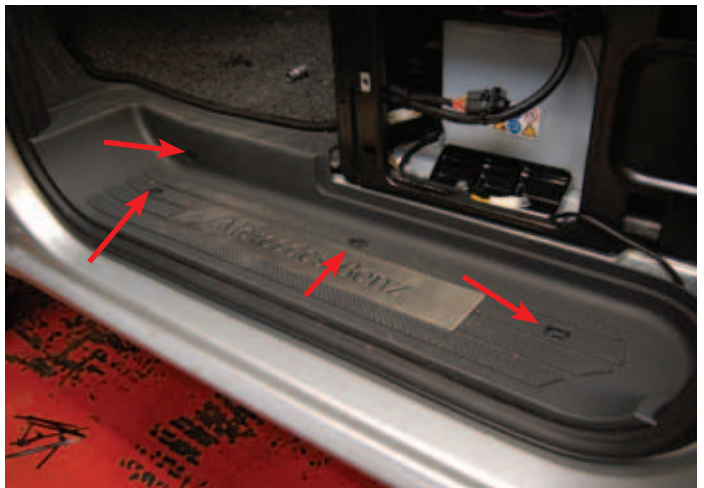

3. Remove the cover above the pedals.
4. Remove the cover of the middle console at the bottom.

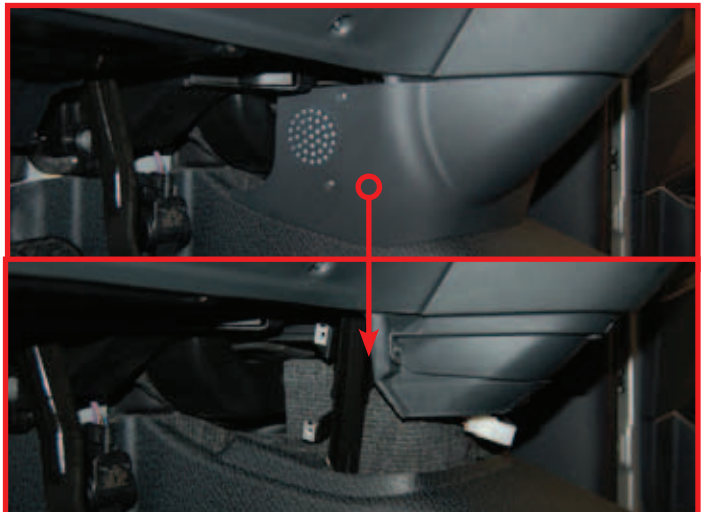

5. Place the supply cable via the A style to the space above the pedals.



#### 4.7.1 Speedsignal

1. Stick both hooks in the holes of the instrument cluster (see small picture) and gently turn them 90°. Next, pull the entire instrument cluster out of the dashboard.
2. Release the connector on the backside of the instrument cluster.
3. Press the lock and remove the inner black housing (1).
4. Place the yellow cable (nr 18) with the loose connector through the backside to the instrument cluster.
5. Place this cable in position 9 of the connector.
6. Re-Mount the connector and the instrument cluster in reverse order.



***If the position 9 is already filled, please connect the yellow cable to that cable.***

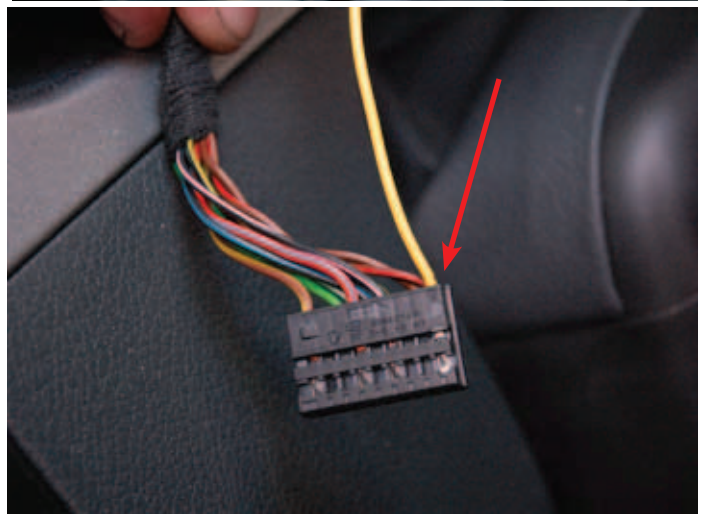

#### 4.7.2 Contact plus

1. Search under de middle console to the connector which been shown in the picture. (from the cigarette lighter)

2. Release the connection.

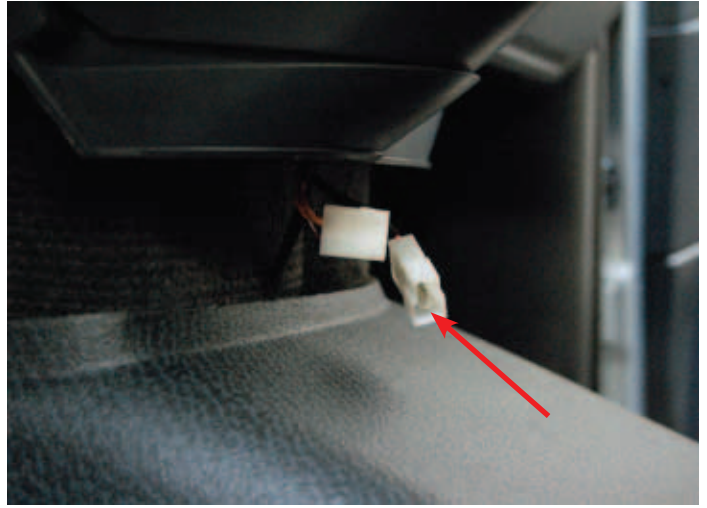

3. Lay the connectors from the VB wiring harness to the released connectors.



- 4. Connect the "VB" connectors to the original connectors.
- 5. Secure the wiring harness out of sight when re-mounting the covers.
- 6. Mount the covers back in reverse order.
- 7. Connect the connector of the speed and supply cable to the wiring harness under the seat.





## 4.8 Warranty

1. Place the warranty stickers A+B in the B-style of the passengerside of the vehicle.



2. Place the sticker with the fuses instruction on the seat cover.

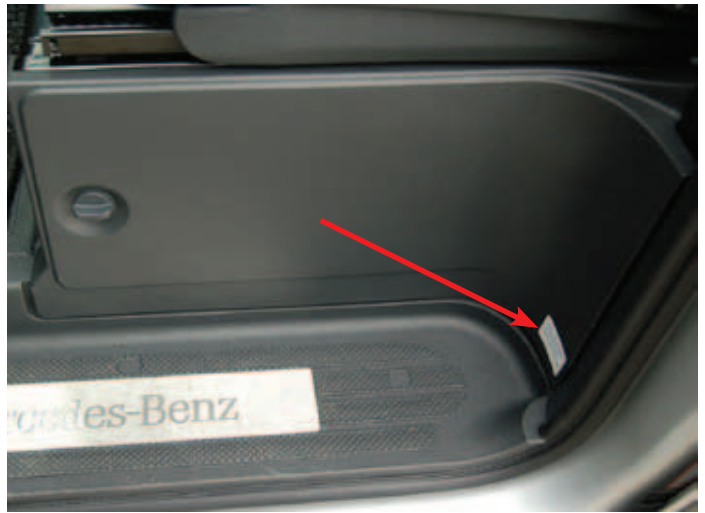

## 4.9 Calibration

1. Mount the fuses (**F1**=40A + **F2** = 7,5A)
2. Switch on the ignition.
3. Make sure the vehicle is standing on it's wheels, on a level surface.
4. Briefly press the **SERVICE**-key (LED lights), and enter the following code within 10 seconds:

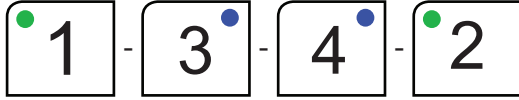

The system will give a long beep and reboot.

5. During the first beep, hold the **SERVICE**-key, until a second long beep is heard. Now enter the following code within 10 seconds:

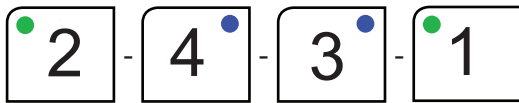

The calibration mode is activated. The rear axle LED and **CHECK** LED will blink.

6. Use the arrow-keys to raise the vehicle to place the calibration supports.



**For an overview of the right calibration supports for this kit, please see chapter 2.**

7. Check if the calibration support are placed properly.
8. Use the arrow-keys to release all air from the air springs, until the hissing sound stops.
9. When the correct height is set, hold the **SERVICE**-key until a long beep is heard. The ride height is now stored.
10. Briefly press the **SERVICE**-key. The calibration mode is now closed. The system will reboot again
11. Briefly press the **SERVICE**-key to leave the Service mode.
12. Use the arrow key to lift the vehicle, so the calibration supports can be removed.
13. Remove the calibration supports.
14. Set the vehicle at ride height.
15. Switch off the ignition.
16. Secure all bolts and nuts, which were marked in this manual with **\*\***
17. Let an official dealer check the head-light adjustment.
18. Check the vehicle according to the checklist in this manual.

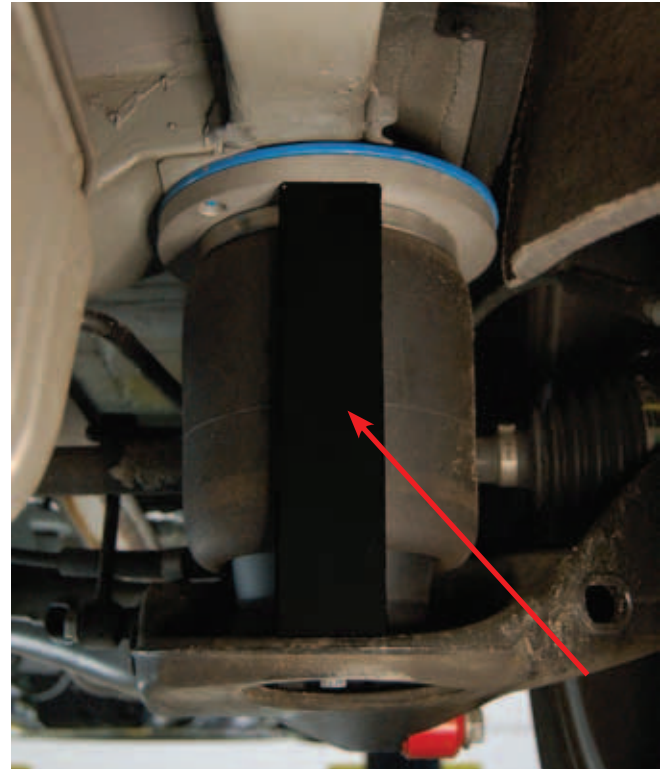
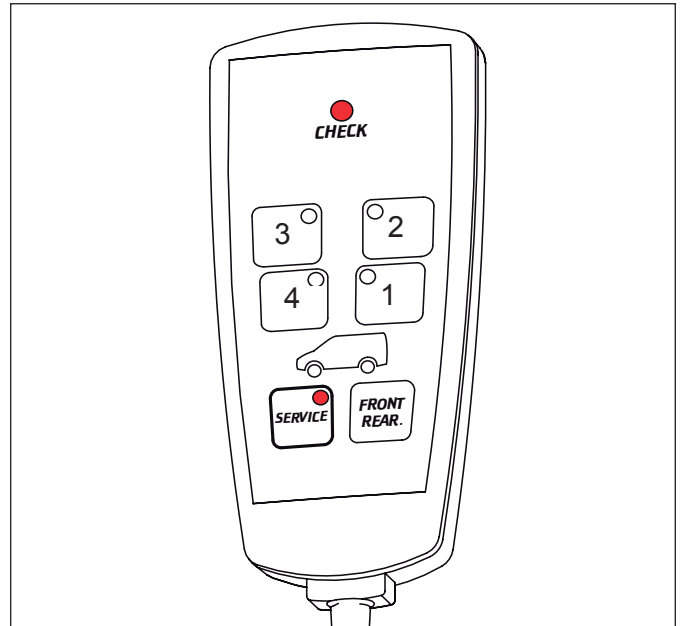

## 5. Checklist

### 5.1 System finishing

OK

- 1.1 Chassis height, near the rear axle, checked.
- 1.2 Shock absorbers set-up and relieved of air
- 1.3 Height sensor correctly mounted
- 1.4 Rear axle correctly aligned.
- 1.5 Tubes, cables and connectors correctly mounted.
- 1.6 Bolts and nuts tightened on the right torque and checked off in the manual.
- 1.7 System checked for air-leaks
- 1.8 Space around the air-springs checked
- 1.9 Present documentation checked.
- 1.10 Warranty form filled out and identification sticker stucked.
- 1.11 Transformation of air suspension written down in maintenance booklet.

### 5.2 Functions of system

OK

- 2.1 Manual raising
- 2.2 Automatic lowering above 5 km/h
- 2.3 Manual lowering
- 2.4 Automatic raising above 5 km/h
- 2.5 Test drive approved

# 6. Wiring diagram

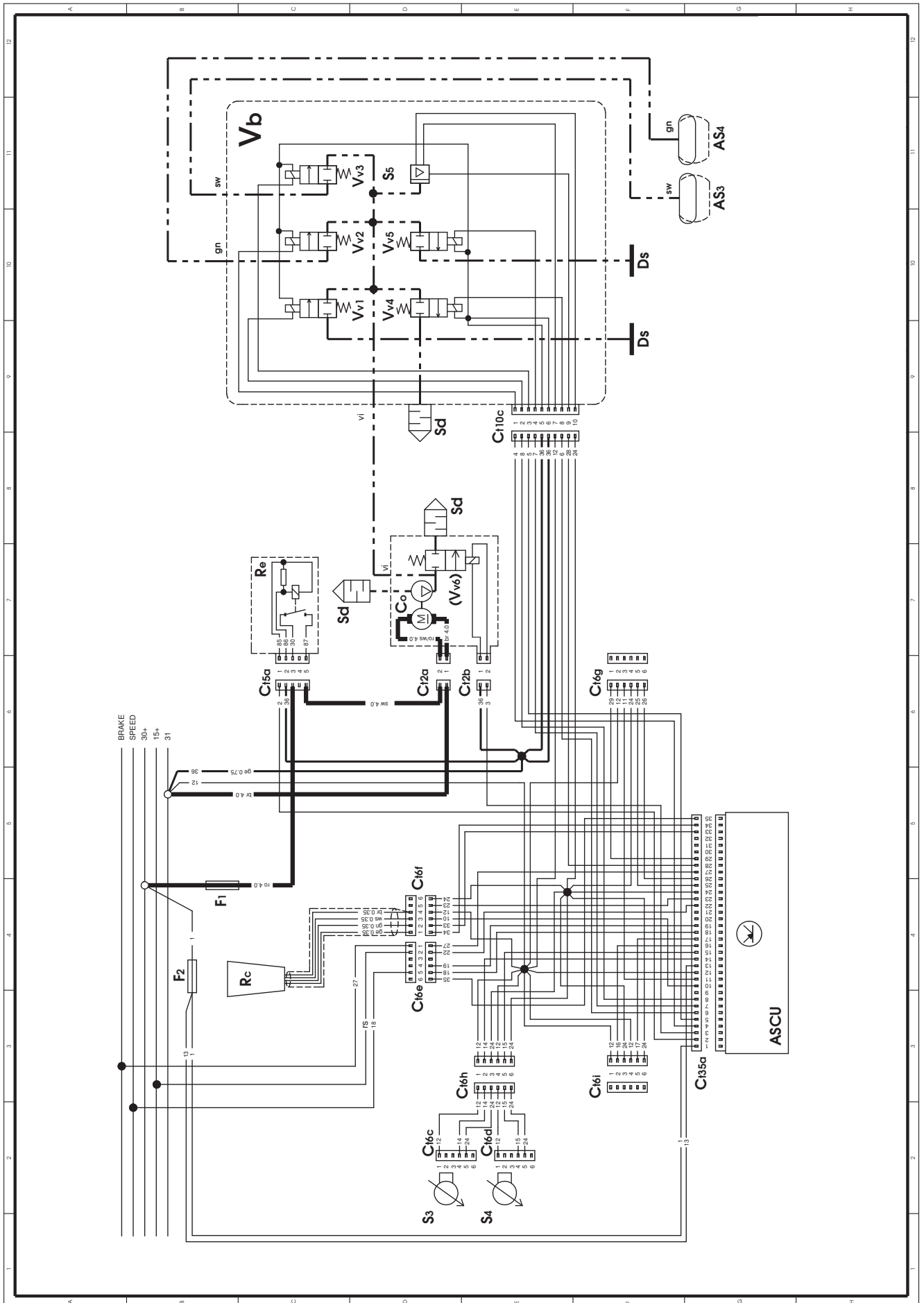

| Name  | Description                                      |
|---|--|
| ASCU  | VB-ASCU (control unit)                           |
| AS3   | Air spring left                                  |
| AS4   | Air spring right                                 |
| Co  | Compressor                                       |
| Ct1a  | Connector, 1-pole, to dashboard                  |
| Ct1b  | Connector, 1-pole, to handbrake                  |
| Ct2a  | Connector, 2-pole, compressor                    |
| Ct2b  | Connector, 2-pole, valve on compressor           |
| Ct5a  | Connector, 5-pole, relay Re                      |
| Ct6a  | Connector, 6-pole, height sensor S3              |
| Ct6b  | Connector, 6-pole, height sensor S4              |
| Ct6e  | Connector, 6-pole, VB-supply cable (white)       |
| Ct6f  | Connector, 6-pole, remote control Rc (white)     |
| Ct6g  | Connector, 6-pole, option connector              |
| Ct10a   | Connector, 10-pole, valve block connection       |
| Ct35a   | Connector, 35-pole, VB-ASCU control unit         |
| Da  | Dashboard  |
| Di  | Diode  |
| Ds  | Blind plug                                       |
| F1  | Fuse compressor, 40A                             |
| F2  | Fuse compressor, 7,5A                            |
| F3  | Fuse BF1 on the battery 30A                      |
| Speed   | Speed signal                                     |
| Brake   | Brake signal                                     |
| Rc  | Remote control                                   |
| Re  | Compressor relay                                 |
| S3  | Height sensor left                               |
| S4  | Height sensor right                              |
| S5  | Pressure sensor on valve block                   |
| Vb  | Valve block                                      |
| Vv1   | Valve for air-spring, right front on valve block |
| Vv2   | Valve for air-spring, left rear on valve block   |
| Vv3   | Valve for air-spring, right rear on valve block  |
| Vv4   | Dump valve, to release air on valve block        |
| Vv5   | Valve for air-spring, left front on valve block  |
| Vv6   | Release valve on compressor                      |
| <b>Colourcode: (not mentioned, is yellow with wire number)</b>                      |  |
| bl  | Blue   |
| br  | Brown  |
| ge  | Yellow   |
| gn  | Green  |
| ro  | Red  |
| ro/ws   | Red/White  |
| rs  | Pink   |
| sw  | Black  |
| vi  | Violet   |
| ws  | White  |
|  | 0,50 mm <sup>2</sup>                             |
|  | 0.75 mm <sup>2</sup>                             |
|  | 4,00 mm <sup>2</sup>                             |
|  | Air-tube   |



## 7. Exploded view

### 7.1 Compressorbox

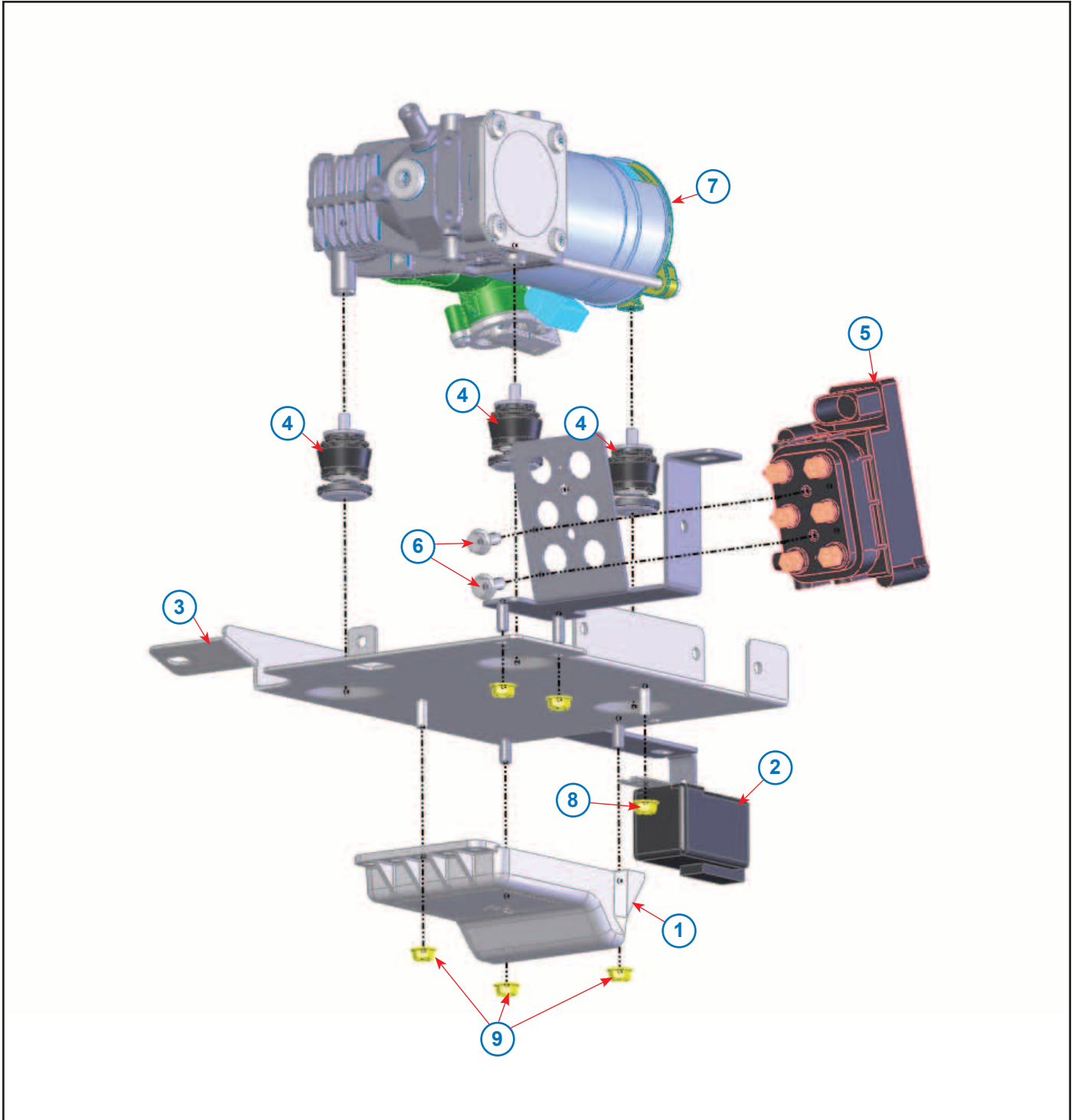

| <b>Item</b> | <b>Qt.</b> | <b>Description</b>    | <b>Art. nr.</b>  |
|-------------|------------|-----------------------|------------------|
| 1           | 1          | ASCU                  | 105 212 20 10    |
| 2           | 1          | Relais 40 Amp         | 003 050 00 07    |
| 3           | 1          | Compressorbox bracket | 105 213 11 31    |
| 4           | 3          | Compressorhangingset  | 805 235 00 85    |
| 5           | 1          | Valve block           | 105 225 06 71    |
| 6           | 2          | Screw for plastic     | 001 520 60 12AA  |
| 7           | 1          | Compressor            | 105 211 11 00    |
| 8           | 3          | Flange lock nut       | 001 110 60 01 AB |
| 9           | 3          | Tensilock nut M6      | 001 110 60 00 AB |

## 7.2 Air-spring



## 7.3 Heightsensor

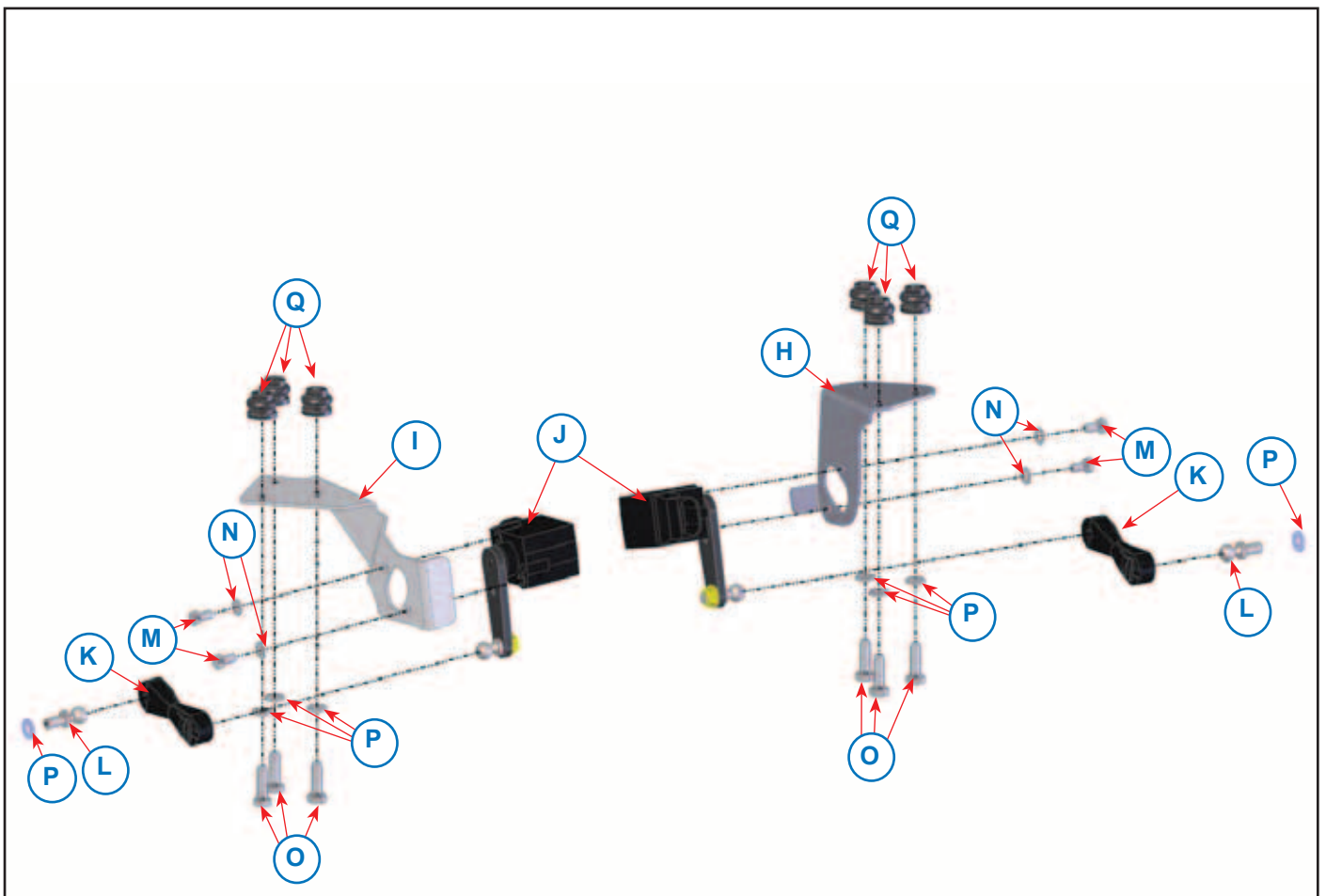

| <b>Item</b> | <b>Qt</b> | <b>Description</b>                     | <b>Art. nr.</b>   |
|-------------|-----------|--|-------------------|
| A           | 2         | Upper spring plate                     | 105 203 01 83     |
| B           | 2         | Air-spring                             | 105 203 25 32     |
| C           | 2         | Clamping plate                         | 105 205 00 83     |
| D           | 2         | Washer M8                              | 001 120 80 00 A   |
| E           | 2         | Bolt M8x30 Kl. 8.8                     | 001 010 80 300 AA |
| F           | 4         | Countersunk Allan screw M8x16 Kl. 10.9 | 001 050 80 16 CA  |
| G           | 4         | Flange lock nut M6 Kl. 8.8             | 001 110 60 00 AB  |

| <b>Item</b> | <b>Qt.</b> | <b>Description</b>                                     | <b>Art. nr.</b>  |
|-------------|------------|--|------------------|
| H           | 1          | Heightsensor bracket right                             | 006 209 01 44    |
| I           | 1          | Heightsensor bracket left                              | 006 209 01 45    |
| J           | 2          | Heightsensor   | 006 209 10 30    |
| K           | 2          | Heightsensor rod L=50mm HtoH                           | 105 209 51 54    |
|             | 2          | Heightsensor rod L=105mm HtoH<br>(only for 4X4 models) | 105 209 50 72    |
| L           | 2          | Ball joint M6  | 105 209 51 78    |
| M           | 4          | Bolt M5x10 Kl. 8.8                                     | 001 010 50 10 AA |
| N           | 4          | Washer M5  | 001 120 50 00 AA |
| O           | 6          | Bolt M6x20 Kl. 8.8                                     | 001 010 60 20 AA |
| P           | 8          | Washer M6  | 001 120 60 00 A  |
| Q           | 6          | Blind rivet nut M6                                     | 001 290 80 01    |

## 8. Xenon modification

1. Disconnect the original heightsensorarm
2. Set the vehicle at ride height.
3. Disassemble the original heightsensor.
4. Remove the original heightsensorbracket.
5. Grind the bracket flat as shown on the picture.



**Protect the surface with an anti corrosion substance. For example: protective coating or spray-wax.**



6. Mount the original heightsensorbracket.
7. Remove the ball joint out of the original heightsensor.



8. Mount the original heightsensor back at its bracket together with the mounting bracket for the heightsensorarm.



**1 x Bolt M6x20**  
**2 x Washer M6**  
**1 x Lock nut M6**

**8 Nm**

9. Mount the original heightsensorarm to the mounting bracket, the dimension Y must be the same length as the original heightsensorrod.
10. Demount the original heightsensor with bracket.

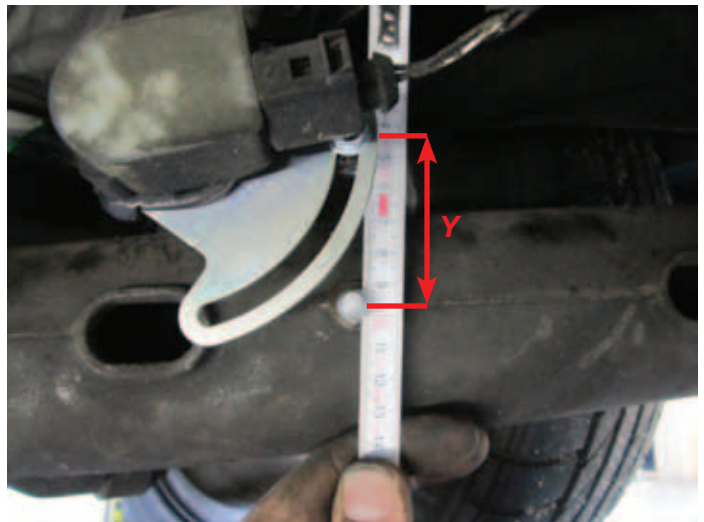

11. Mount a blind rivet nut M8 into the hole in the cross beam. The hole is in the cross beam in front of the differential on the left side of the driving shaft.



|   |                              |
|---|------------------------------|
|  | <b>1x Blind rivet nut M8</b> |
| -   |                              |

|  |   |
|--|---|
|  | <b><i>The picture was taken from the front side of the vehicle.</i></b> |
|--|---|

12. Mount the original heightsensor bracket with the heightsensor at the shown place to make place for the VB heightsensor.

|   |                       |
|---|-----------------------|
|  | <b>1 x Bolt M8x20</b> |
| <b>15 Nm</b>  | <b>1 x Washer M8</b>  |

13. Connect the original connector back to the original heightsensor.
14. Continue on page 11 with step 1.









VB-Airsuspension is producing, as one of the few European manufacturers, a very broad range of different (air-) suspension systems. From reinforced coil springs, semi-air suspension systems, up to complete full air-suspension systems, we provide solutions for customers with different vehicle types, like ambulances, minibuses, car transporters, motorhomes, etc. Now you can see why more and more commercial vehicle body manufacturers specify VB-Airsuspension on their vehicles.



Dealer:



VB-Airsuspension B.V.  
 postbus 130, 7050 AC Varsseveld  
 Frankenweg 3, Varsseveld  
 The Netherlands  
 +31 (0)315 - 24 10 75  
 info@vbairsuspension.com  
 www.vbairsuspension.com



VB-Airsuspension Deutschland GmbH  
 Heydastraße 10  
 58093 Hagen  
 Germany  
 +49 (0)2331 62474 0  
 info@vbairsuspension.de  
 www.vbairsuspension.de

VB-Airsuspension France S.A.R.L.  
 73, rue Principale  
 67310 Traenheim  
 France  
 +33 (0)689 - 06 24 69  
 info@vbairsuspension.fr  
 www.vbairsuspension.fr

VB-Airsuspension UK L.T.D.  
 Unit 13, Elder Court, Lions Drive  
 BB1 2EQ Blackburn, Lancashire  
 United Kingdom  
 +44(0) 12 54 84 80 10  
 info@vbairsuspension.co.uk  
 www.vbairsuspension.co.uk